

Lowercase letters

a

a body letter

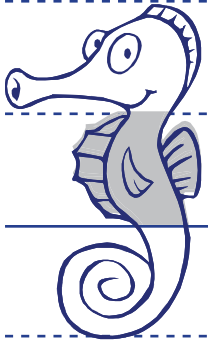

a A

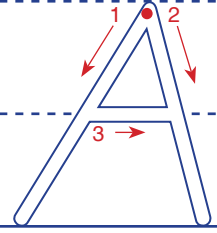
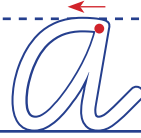

a a a a a a a

Lowercase letters

b

a head and body letter

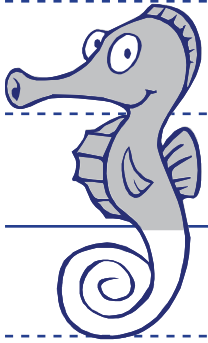

b B

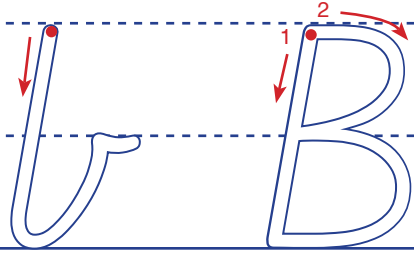

b b b b b b

Lowercase letters

c

a body letter

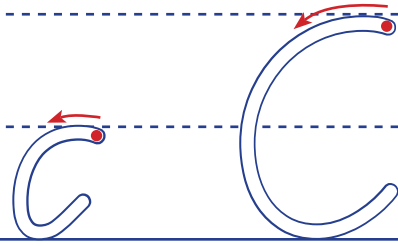
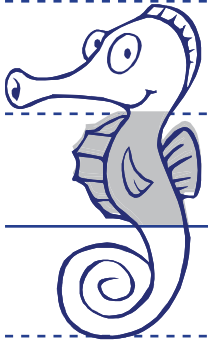

Lowercase letters

d

a head and body letter

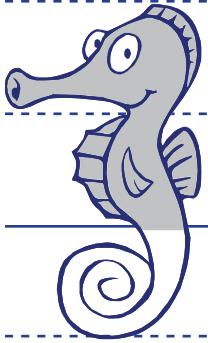

d D

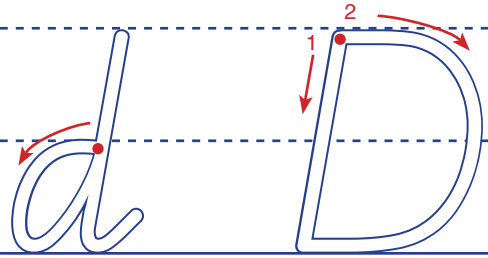

d d d d d d

a body letter

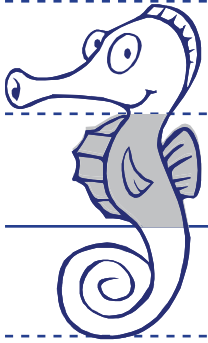

e E

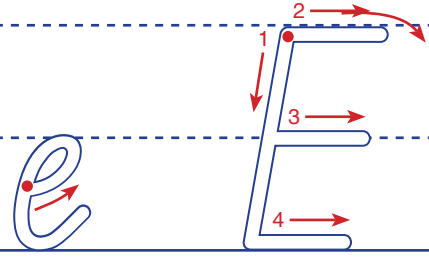

e e e e e e e e

Lowercase letters

f

a head, body and tail letter

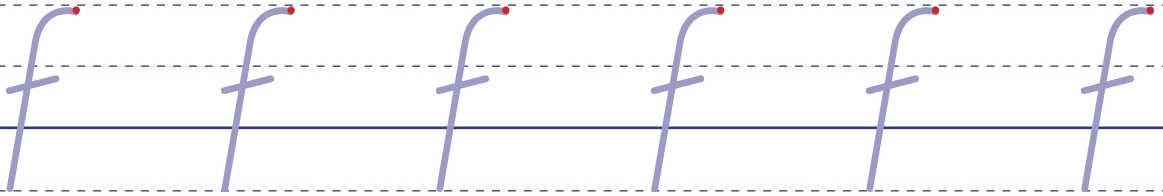
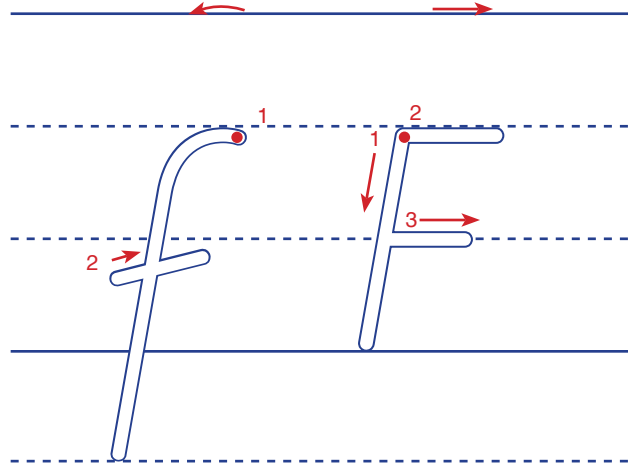
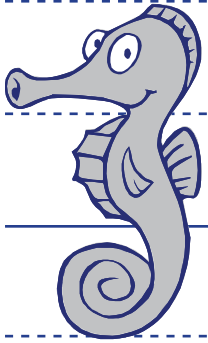

Lowercase letters

g

a body and tail letter

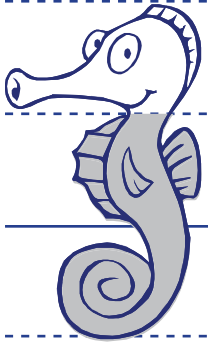

g G

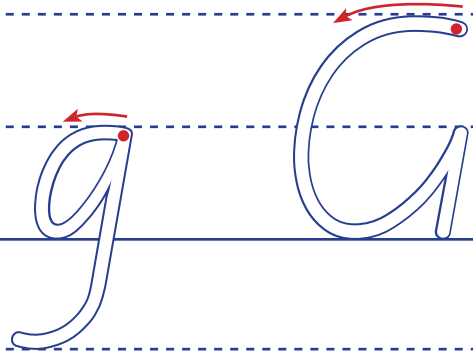
Large lowercase 'g' and uppercase 'G' are shown in a dark blue color on the first row of handwriting lines.

g g g g g g g

Seven lowercase 'g' characters are shown in a light grey color on the first row of handwriting lines, each with a red dot at the top for starting point.

a head and body letter

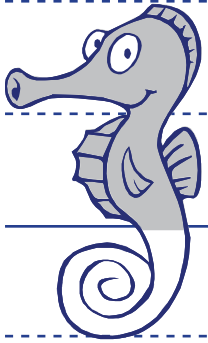

h H

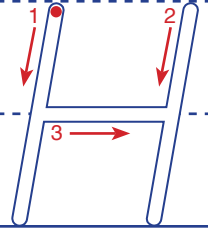
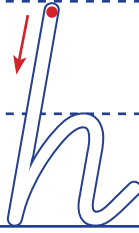

h h h h h h

Lowercase letters

i

a body letter

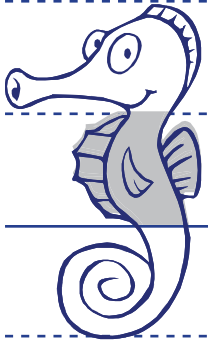

i l

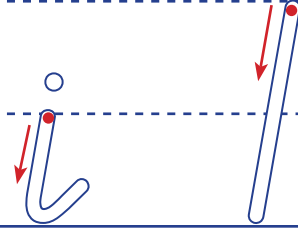

i i i i i i i

Lowercase letters

j

a body and tail letter

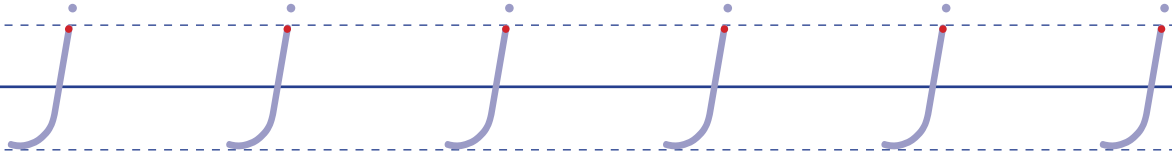
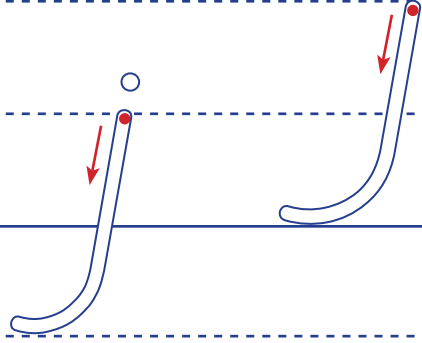
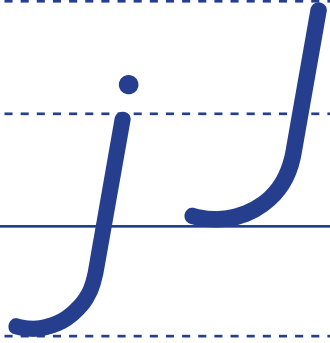
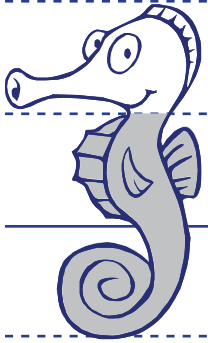

Lowercase letters

k

a head and body letter

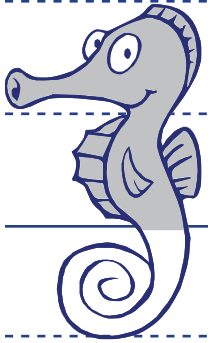

k K

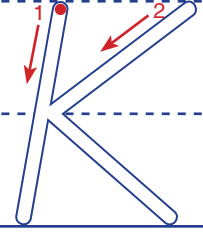
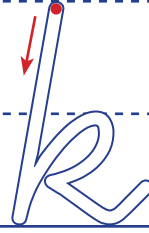

k k k k k k

Lowercase letters

l

a head and body letter

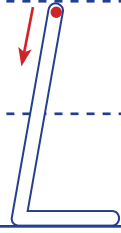
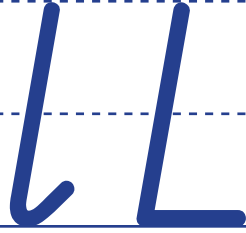
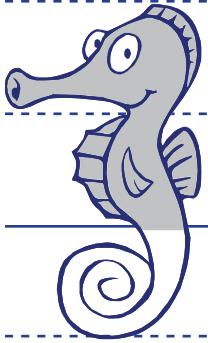

a body letter

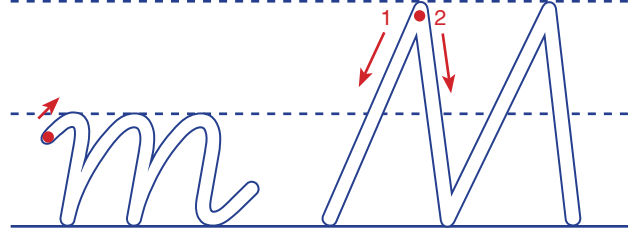

A series of handwriting lines for practice. On the left side, there is a vertical column of seven seahorse illustrations. To the right of the first line, there are six lowercase 'm' characters for tracing, each with a red starting dot. The remaining lines are blank for independent practice.

a body letter

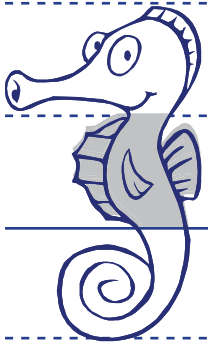

n N

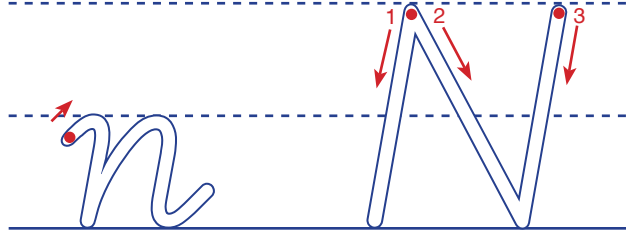

n n n n n n

Lowercase letters

o

a body letter

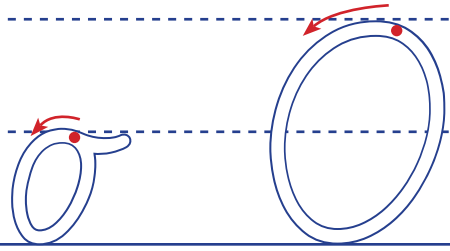
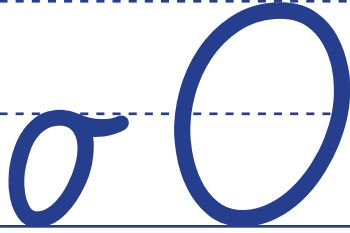
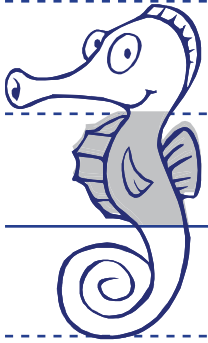

Lowercase letters

p

a body and tail letter

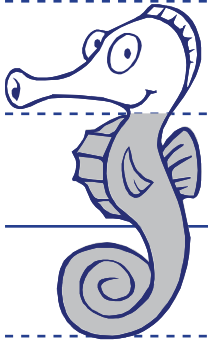

p P

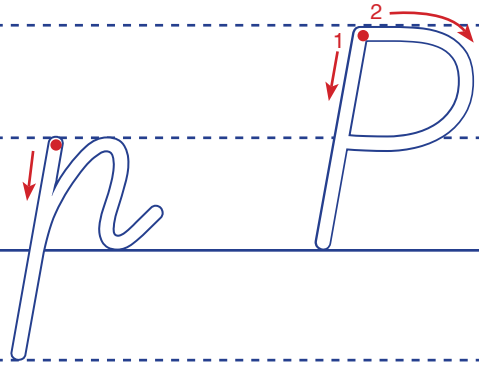

p p p p p p

Lowercase letters

q

a body and tail letter

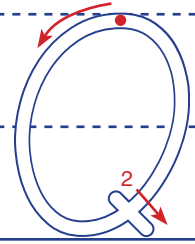
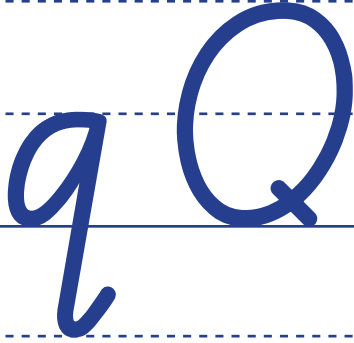
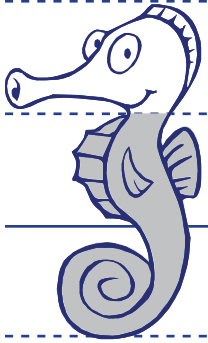

Lowercase letters

r

a body letter

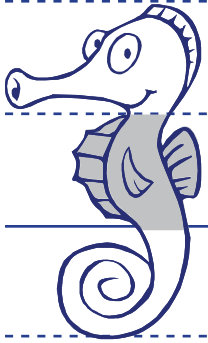

r R

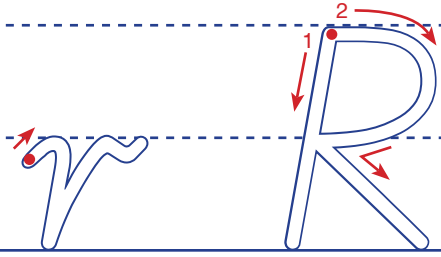

r r r r r r r

a body letter

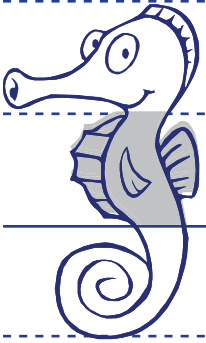

s S

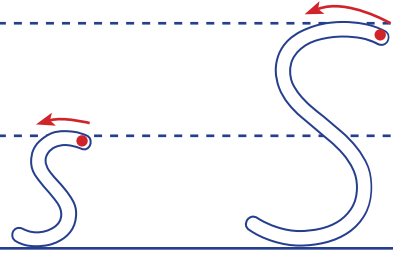

s s s s s s s

Lowercase letters

t

a head and body letter

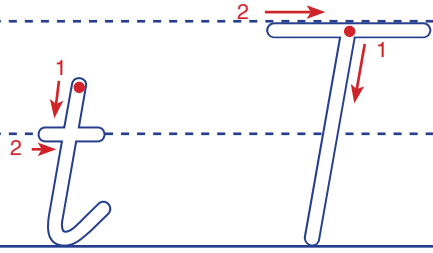
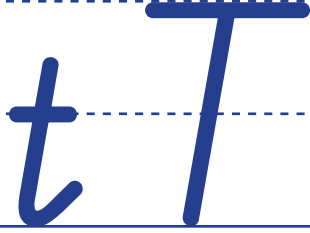
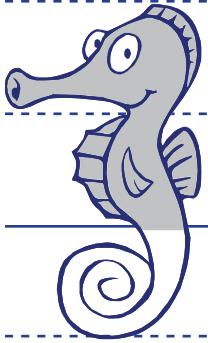

t t t t t t

Lowercase letters

u

a body letter

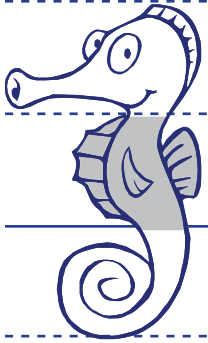

u U

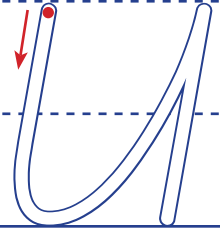
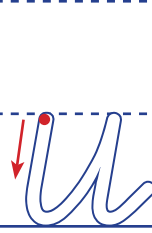

u u u u u u

Lowercase letters

v

a body letter

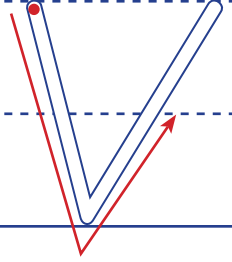
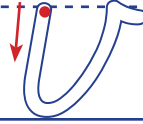
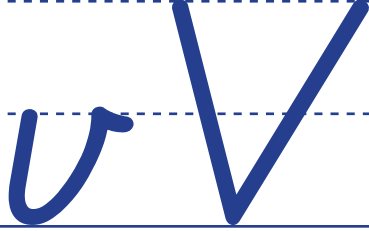
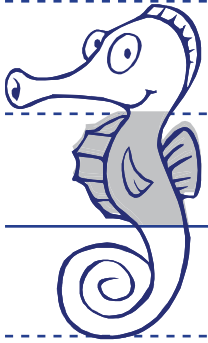

Lowercase letters

w

a body letter

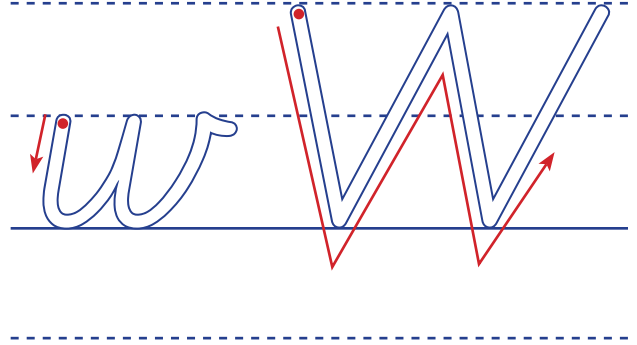

Handwriting practice section with seven rows of three-line guides. Each row starts with a seahorse illustration on the left. The first row contains six lowercase 'w' characters for tracing, each with a red dot at the starting point. The remaining six rows are blank for independent practice.

a body letter

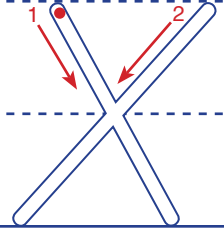
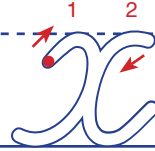
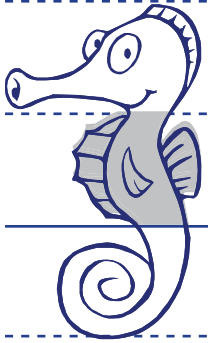

Lowercase letters

y

a body and tail letter

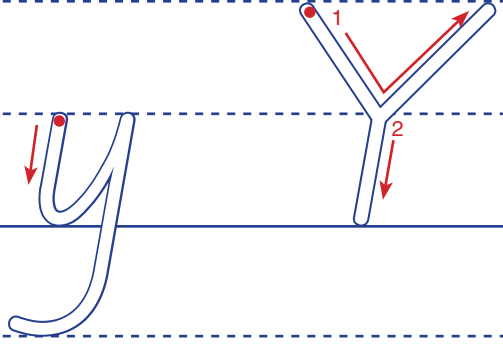
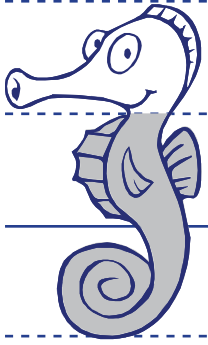

a body and tail letter

